

---

# WHEEL AND TYRE

## CONTENTS

31109000168

<b>GENERAL INFORMATION</b> .....	<b>2</b>	<b>ON-VEHICLE SERVICE</b> .....	<b>4</b>
<b>SERVICE SPECIFICATIONS</b> .....	<b>2</b>	Tyre Inflation Pressure Check .....	4
<b>TROUBLESHOOTING</b> .....	<b>3</b>	Tyre Wear Check .....	4
		Wheel Runout Check .....	4
		<b>WHEEL AND TYRE</b> .....	<b>4</b>
		<b>UNDERFLOOR SPARE TYRE CARRIER</b> .....	<b>5</b>



**GENERAL INFORMATION**

31100010269

Both steel type and aluminium type wheels have been adopted. The type of wheel used depends on the vehicle model.

Items		Vehicles without wide fender	Vehicles with wide fender
Wheel	Type	Steel type	Aluminium type
	Size	15 x 6JJ	16 x 7JJ
	Amount of wheel offset	33	10 ± 1
	Pitch circle diameter (P.C.D.) mm	139.7	139.7
Tyre	Size	235/75 R15	245/70 R16





**SERVICE SPECIFICATIONS**

31100030036

Items		Limit
Tread depth of tyre mm		1.6
Wheel runout (Radial runout) mm	Steel wheel	1.2 or less
	Aluminium wheel	1.0 or less
Wheel runout (Lateral runout) mm	Steel wheel	1.2 or less
	Aluminium wheel	1.0 or less

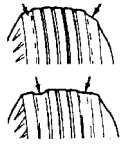
TROUBLESHOOTING

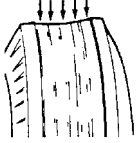
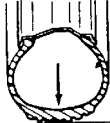
31100070083

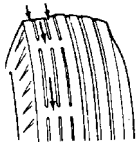
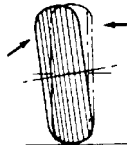
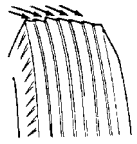
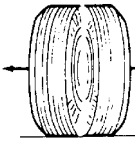
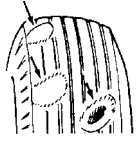
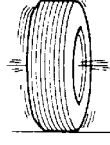
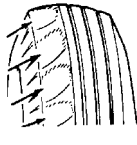
Symptom		Probable cause		Remedy	Reference page
Rapid wear at shoulders	 11X0109	Under-inflation or lack of rotation	 11X0116	Adjust the tyre pressure.	31-4.
Rapid wear at centre	 11X0110	Over-inflation or lack of rotation	 11X0117		
Cracked treads	 11X0111	Under-inflation		Adjust the tyre pressure.	31-4.
Wear on one side	 11X0112	Excessive camber	 11X0118	Inspect the camber.	Refer to GROUP 33A – On-vehicle Service.
Feathered edge	 11X0113	Incorrect toe-in	 11X0119	Adjust the toe-in.	
Bald spots	 11X0114	Unbalanced wheel	 11X0120	Adjust the imbalanced wheels.	–
Scalloped wear	 11X0115	Lack of rotation of tyres or worn or out-of-alignment suspension		Rotate the tyres and check the front suspension alignment.	Refer to GROUP 33A – On-vehicle Service.

**ON-VEHICLE SERVICE**

31100090034

**TYRE INFLATION PRESSURE CHECK**

Check the inflation pressure of the tyres. If it is not within the standard value, make the necessary adjustment.

**TYRE WEAR CHECK**

31100100034

Measure the tread depth of tyres.

**Limit: 1.6 mm**

If the remaining tread depth is less than the limit, replace the tyre.

**NOTE**

When the tread depth of tyres is reduced to 1.6 mm or less, wear indicators will appear.

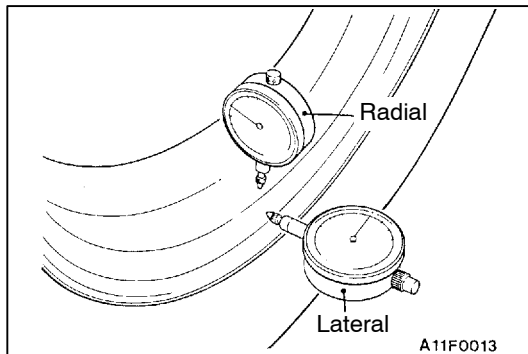
**WHEEL RUNOUT CHECK**

31100110143

Jack up the vehicle so that the wheels are clear of the floor. While slowly turning the wheel, measure wheel runout with a dial indicator.

**Limit:**

Item	Steel wheel	Aluminium wheel
Radial runout mm	1.2	1.0
Lateral runout mm	1.2	1.0

If wheel runout exceeds the limit, replace the wheel.

**WHEEL AND TYRE**

31100130156

**INSTALLATION SERVICE POINT**

Tighten the wheel nut to the specified torque.

**Tightening torque:**

**Steel wheel 118 – 137 Nm**

**Aluminium wheel 98 – 118 Nm**

**UNDERFLOOR SPARE TYRE CARRIER**

31100180014

**REMOVAL AND INSTALLATION**

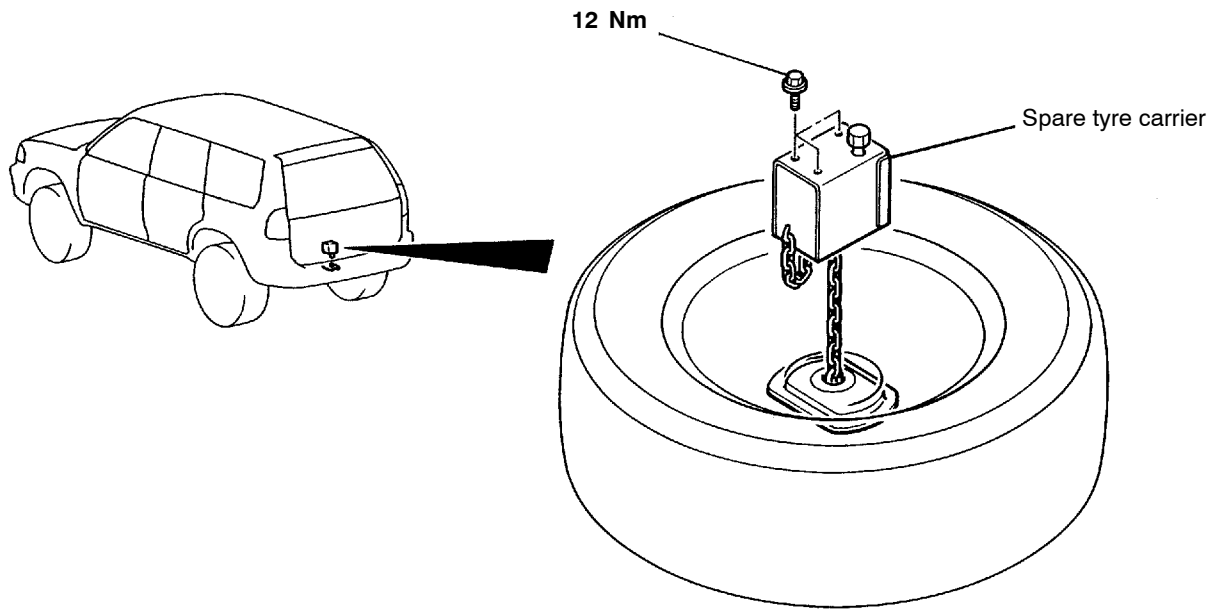

AT0028AA

---

## NOTES